



Cajón con organizador. Organizer unit. Gaveta com organizador. Calaix amb organitzador. Antolatzailearekin tiradera. Caixón con organizador.



Cierre amortiguado. Soft close. Com amortecedor. Tancament suau. Motelgailudun itxierazko. Peche amortecido.



Guías Hettich. Hettich sliding system. Guies Hettich. Guies Hettich. Hettich gidak. Guías Hettich.



Acabado lacado mate. Matte lacquered finish. Cor lacado mate. Acabat lacat mat. Mate lakatzuko bukatua. Acabado lacado mate.



Frentes con relieve

- Sujeción ajustable en altura y profundidad con sistema antivuelco.
- 2 cajones ajustables con cierre amortiguado. Tiradores integrados.
- Frente MDF 19 mm / Lateral 19 mm.
- Height and depth adjustable suspension with anti-detachment system.
- 2 adjustable drawers with silentslow closing. Integrated handles.
- 19 mm MDF front / 19 mm side panels.
- Suspentes réglables en hauteur et en profondeur avec système antidécrochement.
- 2 tiroirs façades réglables avec fermeture ralentie. Poignées intégrées.
- Façades MDF 19 mm / Latérale 19 mm.

BAMBOO 60 (23.6")

Acabados	Referencia
○ Blanco Mate	113 27 060
● Roble Natural	113 24 060
● Moka Mate	113 46 060
● Leaf Mate	113 25 060

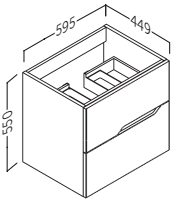

BAMBOO 70 (27.6")

Acabados	Referencia
○ Blanco Mate	113 27 070
● Roble Natural	113 24 070
● Moka Mate	113 46 070
● Leaf Mate	113 25 070

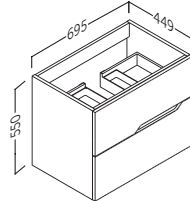

BAMBOO 80 (31.5")

Acabados	Referencia
○ Blanco Mate	113 27 080
● Roble Natural	113 24 080
● Moka Mate	113 46 080
● Leaf Mate	113 25 080

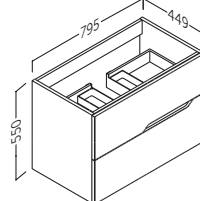

BAMBOO 100 (39.4")

Acabados	Referencia
○ Blanco Mate	113 27 100
● Roble Natural	113 24 100
● Moka Mate	113 46 100
● Leaf Mate	113 25 100

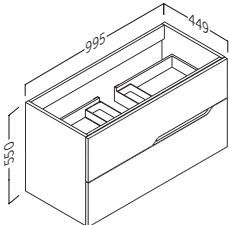

BAMBOO COLUMNA

Acabados	Referencia
○ Blanco Mate	113 27 335
● Roble Natural	113 24 335
● Moka Mate	113 46 335
● Leaf Mate	113 25 335

El estante de cristal puede cambiar su posición +/- 64 mm.



Cierre amortiguado. Soft close. Porta com amortecedor. Tancament suau. Motelgailudun itxierazko. Peche amortecido.



Reversible girando columna. Reversible rotating column. Reversível por coluna rotativa. Reversible girant columna. Zultabe biratuz itzulgarria. Reversible mediante columna xiratarria.

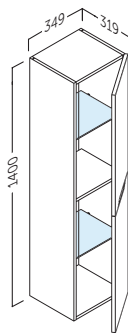

PLANOS TÉCNICOS

MUEBLE

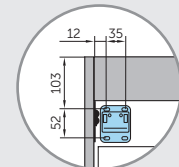
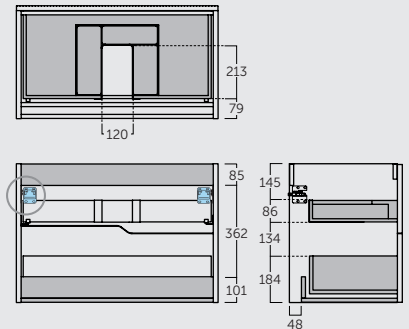

Altura colgador. Hanger height. Hauteur de l'accroche.

COLUMNA

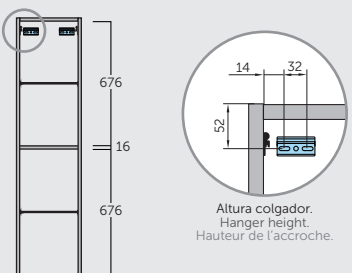

Altura colgador. Hanger height. Hauteur de l'accroche.